

Battery and Solar Kit

Our Battery and Solar Kit provides a simple solution for operating our gas appliances. The battery is enclosed in a sturdy, weatherproof box, while the solar panel ensures that the batteries are always charged and ready for use.



Christie gas appliances require a minimum 12VDC power supply to operate. Our deep-cycle sealed lead-acid 12v—26ah batteries and 20W Solar Panel provide a reliable solution that removes the need to charge the batteries periodically.

Charging the battery in situ with a solar panel eliminates the need for constant battery maintenance. A single solar-maintained battery kit is sufficient to operate two gas appliances.

KEY FEATURES:

Battery

- Deep cycle sealed lead Acid 12v – 26Ah battery
- Integrated solar charging controller with charging status LEDs
- Robust battery box that provides clean, safe storage and improved battery life
- Pre-wired terminals and connectors, including appliance lead(s) and 8 m cable for the solar connection

Solar Panel

- 20W high-efficiency polycrystalline cell technology
- Tempered glass is impact-resistant and easy to clean
- Low 1.5 kg weight for ease of handling and installation
- Roof and pole bracket system provides multiple mounting options

HOW IT WORKS:

Battery

The 26Ah battery provides power to the Christie gas appliances, which require a minimum 12VDC power supply to operate. The battery removes the requirement for mains power and ensures the ignition and control system operates safely.

Solar panel

Once installed, the solar panel sends current to the battery via the solar regulator, ensuring the optimum voltage is maintained. The panel charges the battery in situ, eliminating the need for constant battery maintenance.

BATTERY AND BATTERY BOX

Dimensions:

Width 360 mm
Depth 245 mm
Height 270 mm

Weight: 10.5 kg

Front View

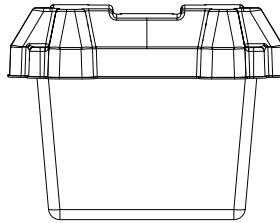

Top View

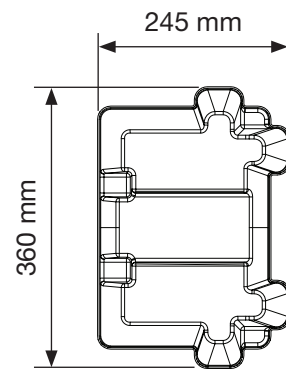

Isometric View

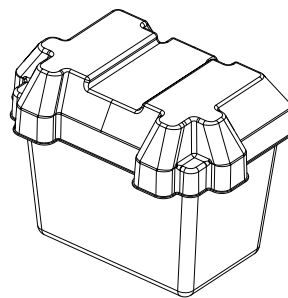

Side View

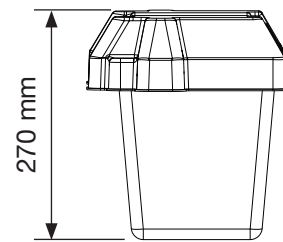

SOLAR PANEL

Dimensions:

Width 435 mm
Depth 356 mm
Height 180 mm

Weight: 1.5 kg

Front View

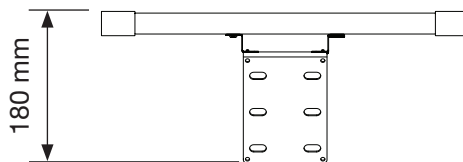

Top View

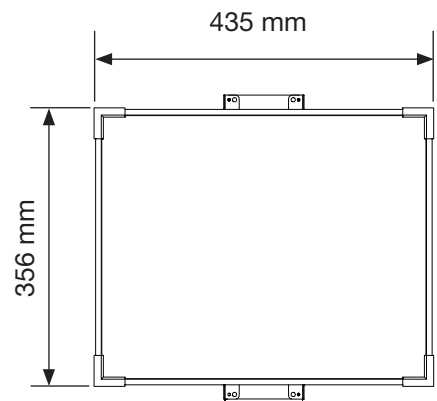

Example Installation Only

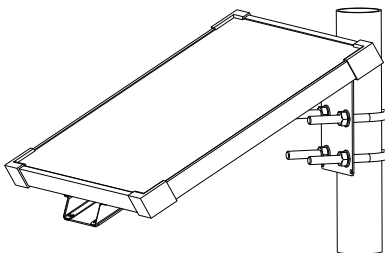

Isometric View

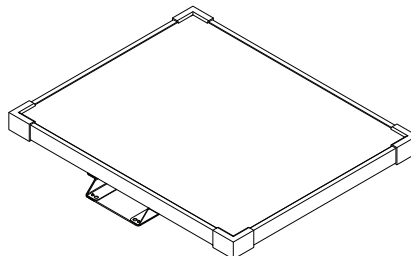

Side View

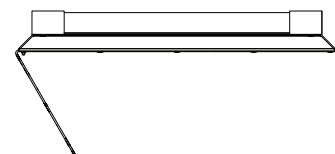

U-bolts and pole not included